

POWERPLUS

POWC | POWE | POWEG | POWERB



WWW.POWERPLUSTIPS.COM





POWC | p4-13
BASIC ELECTRIC POWER TOOLS



POWE | p14-39
ELECTRIC POWER TOOLS



POWE SETS | p40-49



POWEG | p50-61
GARDEN TOOLS



**ONE
FITS ALL**
18V LITHIUM-ION
BATTERY SERIES



POWERB | p62-71
BATTERY OPERATED POWER TOOLS



**ONE
FITS ALL**
18V LITHIUM-ION
BATTERY SERIES



POWERB | p72-75
BATTERIES AND CHARGERS

POWC

The C-Line is an Opening Price Point range. It consists of a small selection of 11 power tools at low-entry prices, carefully picked out in order to cover every important DIY product group. They allow the occasional DIYer to handle all sorts of jobs around the house. Their cool grey colour and compact design create a modern look and feel.





POWC10100
IMPACT DRILL 500W

p6



POWC2020
CIRCULAR SAW 800W

p10



POWC10200
IMPACT DRILL 600W

p6



POWC2030
CIRCULAR SAW 1200W

p11



POWC1030
HAMMER DRILL 900W

p7



POWC2060
RECIPROCATING SAW 710W

p11



POWC1051
DRILL/SCREWDRIVER 12V

p8



POWC30100
ANGLE GRINDER 500W

p12



POWC1061
DRILL/SCREWDRIVER 16V

p8



POWC40100
FINISHING SANDER 150W

p12



POWC1071
DRILL/SCREWDRIVER 20V

p9



POWC40200
PALM SANDER 130W

p13



POWC20100
JIGSAW 350W

p10



POWC6020
CONCRETE / PAINT MIXER 1050W

p13

POWC10100 | POWC10200

IMPACT DRILL

KLOPBOORMACHINE | PERCEUSE À PERCUSSION
SCHLAGBOHRMASCHINE | TALADRO PERCUTOR

POWERPLUS



POWC10100

500W

RATED VOLTAGE - FREQUENCY **230-240V~ 50Hz**
CHUCK TYPE **13mm key chuck**
ROTATION SPEED **0-3000min⁻¹**
IMPACT RATE **35000-41000 strokes per minute**
FUNCTIONS **drilling / impact drilling**
CAPACITY CONCRETE **10mm**
CAPACITY STEEL **6mm**
CAPACITY WOOD **13mm**

FEATURES: lock-on button - key chuck - left/right function - speed control - soft grip

INCLUDED: 1x impact drill - 1x depth stop - 1x auxiliary handle - 1x chuck key



POWC10200

600W

RATED VOLTAGE - FREQUENCY **230-240V~ 50Hz**
CHUCK TYPE **13mm keyless chuck + lock**
ROTATION SPEED **0-3000min⁻¹**
IMPACT RATE **35000-41000 strokes per minute**
FUNCTIONS **drilling / impact drilling**
CAPACITY CONCRETE **10mm**
CAPACITY STEEL **6mm**
CAPACITY WOOD **20mm**

FEATURES: lock-on button - keyless chuck with lock function - left/right function - speed control - soft grip

INCLUDED: 1x impact drill - 1x depth stop - 1x auxiliary handle



POWC1030

HAMMER DRILL

BOORHAMER | MARTEAU PERFORATEUR 900W
BOHRHAMMER | MARTILLO PERCUTOR

POWERPLUS



POWC1030
900W

ROTATION SPEED **800min⁻¹**
FUNCTIONS **drilling / chiseling / hammer drill**
CAPACITY STEEL **13mm**
CAPACITY WOOD **40mm**
CAPACITY CONCRETE **26mm**
IMPACT FORCE **3.5 Joule**
IMPACT RATE **4000 strokes per minute**

FEATURES: SDS PLUS-type - fastening sleeve
- mode selector with safety lock - hammer stop-
drill selection

INCLUDED: 1x hammer drill - 1x spanner



POWC1051 | POWC1061

DRILL/SCREWDRIVER

SCHROEFBOORMACHINE | PERCEUSE / VISSEUSE
BOHRSCHRAUBER | TALADRO / ATORNILLADOR

POWERPLUS



POWC1051

12V

BATTERY CAPACITY **1300mAh Li-Ion**
 CHARGING TIME **3-5h**
 CHUCK TYPE **10mm Sanou keyless chuck**
 ROTATION SPEED **0-650min⁻¹**
 MAX. TORQUE **20Nm**
 TORQUE POSITIONS **18+1**
 FUNCTIONS **drilling / screwdriving**
 CAPACITY STEEL **6mm**
 CAPACITY WOOD **20mm**

FEATURES: LED-worklight - LED battery level indicator - variable speed - left/right function - Sanou keyless chuck - soft grip

INCLUDED: 1x drill/screwdriver - 1x charger - 1x 1300mAh Li-Ion battery - 1x double head screw bit



POWC1061

16V

BATTERY CAPACITY **1300mAh Li-Ion**
 CHARGING TIME **3-5h**
 CHUCK TYPE **10mm Sanou keyless chuck**
 ROTATION SPEED **0-400 / 0-1400min⁻¹**
 MAX. TORQUE **30Nm**
 TORQUE POSITIONS **18+1**
 FUNCTIONS **drilling / screwdriving**
 CAPACITY STEEL **10mm**
 CAPACITY WOOD **20mm**

FEATURES: LED-worklight - LED battery level indicator - left/right function - 2 speed settings - Sanou keyless chuck - soft grip

INCLUDED: 1x drill/screwdriver - 1x charger - 1x 1300mAh Li-Ion battery





POWC1071

DRILL/SCREWDRIIVER

SCHROEFBOORMACHINE | PERCEUSE / VISSEUSE
BOHRSCHRAUBER | TALADRO / ATORNILLADOR



POWC1071 20V

BATTERY CAPACITY **1300mAh Li-Ion**
CHARGING TIME **3-5h**
CHUCK TYPE **10mm Sanou keyless chuck**
ROTATION SPEED **0-400 / 0-1400min⁻¹**
MAX. TORQUE **35Nm**
TORQUE POSITIONS **18+1**
FUNCTIONS **drilling / screwdriving**
CAPACITY STEEL **10mm**
CAPACITY WOOD **20mm**

FEATURES: LED-worklight - LED battery level indicator - left/right function - 2 speed settings - Sanou keyless chuck - soft grip

INCLUDED: 1x drill/screwdriver - 1x charger - 1x 1300mAh Li-Ion battery



5 400338 078828 >



keyless chuck max. 10mm

POWC20100

JIGSAW

DECOUPEERZAAG | SCIE SAUTEUSE
STICHSÄGE | SIERRA DE CALAR



POWC20100 350W

RATED VOLTAGE - FREQUENCY
230-240V ~ 50Hz
ROTATION SPEED **3000min⁻¹**
CAPACITY STEEL **6mm**
CAPACITY WOOD **45mm**
CAPACITY PLASTIC **10mm**

FEATURES: lock-on button - soft grip -
adjustable base - T+U shaped

INCLUDED: 1x jigsaw - 1x blade for wood -
1x blade for metal - 1x dust adaptor
1x hex key



POWC2020

CIRCULAR SAW

CIRKELZAAG | SCIE CIRCULAIRE
HANDKREISSÄGE | SIERRA CIRCULAR

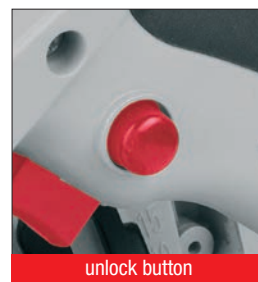

POWC2020 800W

RATED VOLTAGE - FREQUENCY
220-240V ~ 50Hz
ROTATION SPEED **4500min⁻¹**
MAX. CUTTING CAPACITY
90°: **45mm** / 45°: **30mm**
BLADE SIZE **Ø140x16x2mm - 18T**

FEATURES: unlock button - safety guard -
soft grip - depth setting - guide handle -
adjustable angle

INCLUDED: 1x circular saw - 1x side guide -
1x hex key - 1x blade for wood - 1x spanner



POWC2030

CIRCULAR SAW

CIRKELZAAG | SCIE CIRCULAIRE
HANDKREISSÄGE | SIERRA CIRCULAR



adjustable angle

POWC2030 1200W

RATED VOLTAGE - FREQUENCY

220-240V ~ 50Hz

ROTATION SPEED **5800min⁻¹**

MAX. CUTTING CAPACITY

90°: **62mm** / 45°: **42mm**

BLADE SIZE **Ø185x20x2.4mm - 24T**

FEATURES: unlock button - safety guard -
soft grip - depth setting - guide handle -
adjustable angle

INCLUDED: 1x circular saw - 1x side guide
- 1x hex key - 1x blade for wood



5 400338 075360 >



POWERPLUS

POWC2060

RECIPROCATING SAW

RECIPROZAAG | SCIE SABRE
SÄBELSÄGE | SIERRA DE ESPADA



quick blade change

POWC2060 710W

RATED VOLTAGE - FREQUENCY

220-240V ~ 50Hz

ROTATION SPEED **0-2800min⁻¹**

MAX. CUTTING DEPTH WOOD **115mm**

MAX. CUTTING DEPTH STEEL **5mm**

FEATURES: lock-on button - soft grip -
adjustable pivot shoe - quick blade
change

INCLUDED: 1x reciprocating saw -
1x blade for metal - 1x blade for wood -
1x hex key



5 400338 075353 >



POWC30100

ANGLE GRINDER

HAAKSE SLIJPER | MEULEUSE D'ANGLE
WINKELSCHLEIFER | AMOLADORA ANGULAR

POWERPLUS



POWC30100
500W

RATED VOLTAGE - FREQUENCY
230-240V~ 50Hz
ROTATION SPEED **11000min⁻¹**
DISC DIAMETER **115mm**
SPINDLE THREAD **M14**

FEATURES: auxiliary handle (2 positions) - spindle lock - safety guard - soft grip

INCLUDED: 1x angle grinder - 1x auxiliary handle - 1x spanner - 1x safety guard



POWC40100

FINISHING SANDER

VLAKSCHUURMACHINE | PONCEUSE VIBRANTE
SCHWINGSCHLEIFER | LIJADORA ORBITAL



POWC40100
150W

RATED VOLTAGE - FREQUENCY
220-240V~ 50Hz
OSCILLATION SPEED **22000min⁻¹**
SANDING SURFACE **185x90mm**
SANDPAPER **240x90mm**

FEATURES: paper clamps - soft grip

INCLUDED: 1x finishing sander - 1x dust adaptor - 1x sandpaper (G240)



POWC40200

PALM SANDER

HANDPALMSCHUURMACHINE | PONCEUSE À MAIN
HANDSCHLEIFER | LIJADORA DE MANO



dustproof on/off-switch



POWC40200

130W

RATED VOLTAGE - FREQUENCY

220-240V ~ 50Hz

OSCILLATION SPEED 28000min⁻¹

SANDING SURFACE 140x140x80mm

FEATURES: dustproof on/off-switch -
hook & loop system

INCLUDED: 1x palm sander - 1x dust
adaptor - 1x sandpaper (G240)



5 400338 082832 >

POWERPLUS

POWC6020

CONCRETE / PAINT MIXER

BETON-/VERFMENGER | MÉLANGEUR À BÉTON/PEINTURE
RÜHRWERK | MEZCLADOR ELÉCTRICO

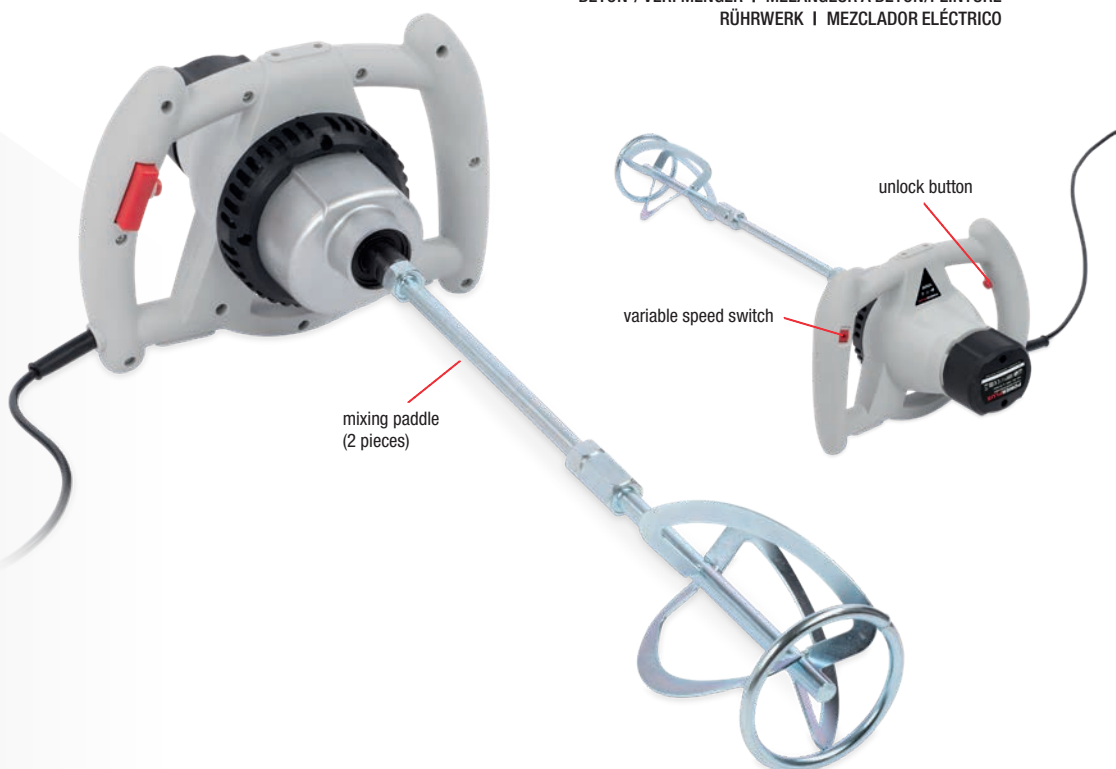

POWC6020

1050W

RATED VOLTAGE - FREQUENCY

230-240V ~ 50Hz

ROTATION SPEED 100-700min⁻¹

CONNECTION TYPE M14

MAX. TORQUE 30Nm

NUMBERS OF GEARS 6

DIMENSIONS MIXING PADDLE

Ø100mm x L 500mm

FEATURES: aluminium gear box - variable
speed - unlock button

INCLUDED: 1x concrete / paint mixer -
1x mixing paddle (2 pieces)



5 400338 076367 >

POWE

The E-Line offers an attractive mix of DIY tools at very competitive prices, without having to compromise on basic quality standards. It has a modern look and feel and can be recognised by its dark grey colour and compact design. Due to its upgraded quality and attractive look and feel, this E-Line is positioned as a strong Opening Price Point line.





POWE00015
SCREWDRIVER 3.6V

p17



POWE00031
DRILL/SCREWDRIVER 14.4V

p18



POWE00042
DRILL/SCREWDRIVER 18V

p18



POWE10025
IMPACT DRILL 600W

p19



POWE10030
IMPACT DRILL 720W

p19



POWE10035
IMPACT DRILL 950W

p21



POWE10060
HAMMER DRILL 900W

p22



POWE10081
HAMMER DRILL 1600W

p22



POWE10090
DEMOLITION HAMMER 1500W

p23



POWE20010
ANGLE GRINDER 650W

p24



POWE20020
ANGLE GRINDER 900W

p24



POWE20030
ANGLE GRINDER 2200W

p25



POWE30010
JIGSAW 450W

p26



POWE30015
JIGSAW 710W

p26



POWE30030
RECIPROCATING SAW 710W

p27



POWE30040
MINI PLUNGE SAW 500W

p27



POWE30050
CIRCULAR SAW 1200W

p28



POWE40010
FINISHING SANDER 180W

p29



POWE40020
PALM SANDER 140W

p29



POWE40030
ECCENTRIC SANDER 450W

p30



POWE40040
BELT SANDER 1010W

p30



POWE80090
POWER STATION 4-IN-1

p37



POWE40050
TRIANGULAR SANDER 180W

p31



POWE80060
MULTITOOL 135W

p38



POWE41030
ANGLE POLISHER 1200W

p31



POWE90600
MULTITOOL ACCESSORIES 102 PCS

p38



POWE50002
MITRE SAW 1650W

p32



POWE80080
BENCH GRINDER 150W

p39



POWE60015
VACUUM CLEANER WET/DRY 1000W

p34



POWE80085
BENCH GRINDER 250W

p39



POWE80010
OSCILLATING MULTITOOL 350W

p34



POWE80030
PLANER 900W

p35



POWE80040
HEAT GUN 1600W

p35



POWE80050
WALL SLOTTER 1700W

p36



POWE80070
CONCRETE PAINT/MIXER 1200W

p36



POWE00015

SCREWDRIVER

SCHROEVENDRAAIER | TOURNEVIS
SCHRAUBER | DESTORNILLADOR



rotatable handle



left/right switch

LED worklight

POWE00015

3.6V 

BATTERY CAPACITY **1300mAh Li-ion**
CHARGING TIME **3-5h**
ROTATION SPEED **180min⁻¹**
MAX. TORQUE **2.5Nm**

FEATURES: LED worklight - rotatable handle -
left/right function - soft grip

INCLUDED: 1x screwdriver - 1x charger



5 400338 073045 >

POWE00031 | POWE00042

DRILL/SCREWDRIVER

SCHROEFBOORMACHINE | PERCEUSE / VISSEUSE
BOHRSCHRAUBER | TALADRO / ATORNILLADOR

POWERPLUS



+ EXTRA BATTERY

+ 12x BIT

+1x DOUBLE HEAD SCREW BIT

+1x BIT HOLDER



POWE00031

14.4V



BATTERY CAPACITY **1300mAh Li-Ion**
CHARGING TIME **1h**
CHUCK TYPE **10mm double sleeve keyless chuck**
ROTATION SPEED **0-400 / 0-1500min⁻¹**
MAX. TORQUE **26Nm**
TORQUE POSITIONS **21+1**
FUNCTIONS **drilling / screwdriving**
CAPACITY STEEL **10mm**
CAPACITY WOOD **25mm**

FEATURES: LED worklight - 2 speed settings - double sleeve keyless chuck - LED battery level indicator - quick stop - built-in bit holder - double head screw bit - soft grip

INCLUDED: 1x drill/screwdriver - 12x bit - 1x bit holder
1x double head screw bit - 1x charger - 1x 1300mAh Li-ion battery - 1x BMC



POWE00042

18V



BATTERY CAPACITY **1300mAh Li-Ion**
CHARGING TIME **5h**
CHUCK TYPE **10mm double sleeve keyless chuck**
ROTATION SPEED **0-400 / 0-1500min⁻¹**
MAX. TORQUE **30Nm**
TORQUE POSITIONS **21+1**
FUNCTIONS **drilling / screwdriving**
CAPACITY STEEL **10mm**
CAPACITY WOOD **30mm**

FEATURES: LED worklight - 2 speed settings - double sleeve keyless chuck - LED battery level indicator - quick stop - built-in bit holder - double head screw bit - soft grip

INCLUDED: 1x drill/screwdriver - 12x bit - 1x double head screw bit - 1x bit holder - 1x charger - 2x 1300mAh Li-ion battery - 1x BMC



POWE10025 | POWE10030

IMPACT DRILL

KLOPBOORMACHINE | PERCEUSE À PERCUSSION
SCHLAGBOHRMASCHINE | TALADRO PERCUTOR



POWERPLUS

POWE10025 600W

RATED VOLTAGE - FREQUENCY **230-240V~ 50Hz**
CHUCK TYPE **13mm Sanou key chuck**
ROTATION SPEED **0-3000min⁻¹**
IMPACT RATE **0-48000 strokes per minute**
MAX. TORQUE **3Nm**
FUNCTIONS **drilling / impact drilling**
CAPACITY CONCRETE **13mm**
CAPACITY STEEL **8mm**
CAPACITY WOOD **25mm**

FEATURES: lock-on button - key chuck - left/right function - speed control - soft grip

INCLUDED: 1x impact drill - 1x depth stop - 1x auxiliary handle - 1x chuck key



POWE10030 720W

RATED VOLTAGE - FREQUENCY **230-240V~ 50Hz**
CHUCK TYPE **13mm Sanou keyless chuck + lock**
ROTATION SPEED **0-3000min⁻¹**
IMPACT RATE **0-48000 strokes per minute**
MAX. TORQUE **3Nm**
FUNCTIONS **drilling / impact drilling**
CAPACITY CONCRETE **13mm**
CAPACITY STEEL **8mm**
CAPACITY WOOD **25mm**

FEATURES: lock-on button - keyless chuck with lock function - left/right function - speed control - soft grip

INCLUDED: 1x impact drill - 1x depth stop - 1x auxiliary handle





POWE10035

IMPACT DRILL

KLOPBOORMACHINE | PERCEUSE À PERCUSSION
SCHLAGBOHRMASCHINE | TALADRO PERCUTOR

POWERPLUS



drill and impact
mode selector

keyless chuck

speed
control dial

lock-on button



POWE10035

950W



RATED VOLTAGE - FREQUENCY **230-240V~ 50Hz**
CHUCK TYPE **13mm Sanou keyless chuck + lock**
ROTATION SPEED **0-3000min⁻¹**
IMPACT RATE **0-48000 strokes per minute**
MAX. TORQUE **4.5Nm**
FUNCTIONS **drilling / impact drilling**
CAPACITY CONCRETE **13mm**
CAPACITY STEEL **10mm**
CAPACITY WOOD **25mm**

FEATURES: lock-on button - keyless chuck with lock
function - left/right function - depth stop - speed
control - soft grip

INCLUDED: 1x impact drill - 1x depth stop -
1x auxiliary handle - 1x BMC



POWE10060 | POWE10081

HAMMER DRILL

BOORHAMER | MARTEAU PERFORATEUR
BOHRHAMMER | MARTILLO PERCUTOR

POWERPLUS



POWE10060 900W



RATED VOLTAGE - FREQUENCY **220-240V~ 50Hz**
 CHUCK TYPE **13mm key chuck**
 ROTATION SPEED **850min⁻¹**
 IMPACT RATE **4100 strokes per minute**
 IMPACT FORCE **4J**
 FUNCTIONS **drilling / hammer drilling / chiseling**
 CAPACITY CONCRETE **26mm**
 CAPACITY STEEL **13mm**
 CAPACITY WOOD **40mm**
 CONNECTION TYPE **SDS plus type**

FEATURES: auxiliary handle - key chuck + adaptor - hammer stop - drill stop

INCLUDED: 1x hammer drill - 1x key chuck - 1x depth stop - 1x auxiliary handle - 3x SDS plus type drill (8/10/12 x 150mm) - 1x SDS plus type flat chisel (14x250mm) - 1x SDS plus type pointed chisel (250mm) - 1x dust cap - 1x grease cup - 1x chuck key - 1x spanner - 1x BMC



POWE10081 1600W



RATED VOLTAGE - FREQUENCY **230V~ 50Hz**
 CHUCK TYPE **13mm key chuck**
 ROTATION SPEED **800min⁻¹**
 IMPACT RATE **4000 strokes per minute**
 IMPACT FORCE **6J**
 FUNCTIONS **drilling / hammer drilling / chiseling / chisel rotation**
 CAPACITY CONCRETE **32mm**
 CAPACITY STEEL **13mm**
 CAPACITY WOOD **40mm**
 CONNECTION TYPE **SDS plus type**

FEATURES: auxiliary handle - key chuck - hammer stop - drill stop

INCLUDED: 1x hammer drill - 1x depth stop - 1x spanner - 1x auxiliary handle - 3x SDS plus type drill (8/10/12 x 150mm) - 1x SDS plus type flat chisel (14x250mm) - 1x SDS plus type pointed chisel (250mm) - 1x dust cap - 1x grease cup - 1x BMC



POWE10090

DEMOLITION HAMMER

BREKHAMER | MARTEAU-PIQUEUR
ABBRUCHHAMMER | MARTILLO DEMOLICIÓN

POWERPLUS



POWE10090
1500W



RATED VOLTAGE - FREQUENCY **230V~ 50Hz**
ROTATION SPEED **1400min⁻¹**
IMPACT RATE **1400 strokes per minute**
IMPACT FORCE **40J**
CONNECTION TYPE **HEX**

FEATURES: adjustable auxiliary handle - full metal housing - soft grip

INCLUDED: 1x demolition hammer - 1x auxiliary handle - 1x spanner - 1x flat chisel HEX - 1x pointed chisel HEX - 1x grease cup - 1x BMC



POWE20010 | POWE20020

ANGLE GRINDER

HAAKSE SLIJPER | MEULEUSE D'ANGLE
WINKELSCHLEIFER | AMOLADORA ANGULAR

POWERPLUS



POWE20010 650W

RATED VOLTAGE - FREQUENCY **220-240V~ 50Hz**
ROTATION SPEED **12000min⁻¹**
DISC DIAMETER **Ø115mm**
SPINDLE THREAD **M14**

FEATURES: spindle lock - quick clamp system - auxiliary handle (2 positions)

INCLUDED: 1x angle grinder - 1x safety guard - 1x auxiliary handle - 1x spanner

NOT INCLUDED: disc



POWE20020 900W

RATED VOLTAGE - FREQUENCY **230-240V~ 50Hz**
ROTATION SPEED **12000min⁻¹**
DISC DIAMETER **Ø125mm**
SPINDLE THREAD **M14**

FEATURES: spindle lock - quick clamp system - unlock button - auxiliary handle (2 positions) - soft grip

INCLUDED: 1x angle grinder - 1x safety guard - 1x auxiliary handle - 1x spanner

NOT INCLUDED: disc



POWE20030

ANGLE GRINDER

HAakse SLIJPER | MEULEUSE D'ANGLE
WINKELSCHLEIFER | AMOLADORA ANGULAR

POWERPLUS



POWE20030 2200W

RATED VOLTAGE - FREQUENCY **230-240V~ 50Hz**

ROTATION SPEED **6500min⁻¹**

DISC DIAMETER **Ø230mm**

SPINDLE THREAD **M14**

FEATURES: spindle lock - quick clamp system - safety switch - rotatable handle - soft grip

INCLUDED: 1x angle grinder - 1x safety guard - 1x auxiliary handle (3 positions) - 1x spanner

NOT INCLUDED: disc



position regulator button for main handle

POWE30010 | POWE30015

JIGSAW

DECOUPEERZAAG | SCIE SAUTEUSE
STICHSÄGE | SIERRA DE CALAR

POWERPLUS



POWE30010

450W

RATED VOLTAGE - FREQUENCY **230-240V~ 50Hz**
ROTATION SPEED **3000min⁻¹**
CAPACITY WOOD **55mm**

FEATURES: adjustable base - U-shaped connection - lock-on button - soft grip

INCLUDED: 1x jigsaw - 1x blade for wood - 1x hex key



POWE30015

710W

RATED VOLTAGE - FREQUENCY **230-240V~ 50Hz**
ROTATION SPEED **0-2800min⁻¹**
PENDULUM CUTTING **4 positions**
CAPACITY STEEL **8mm**
CAPACITY WOOD **65mm**

FEATURES: adjustable base - T-shaped connection - lock-on button - quick blade change - soft grip - LED worklight - speed control

INCLUDED: 1x jigsaw - 1x dust adaptor - 1x blade for wood - 1x side guide - 1x hex key



quick blade change

POWE30030

RECIPROCATING SAW

RECIPROZAAG | SCIE SABRE
SÄBELSÄGE | SIERRA DE ESPADA

POWERPLUS

POWE30030
710W

RATED VOLTAGE - FREQUENCY
220-240V ~ 50Hz
ROTATION SPEED **0-2800min⁻¹**
MAX. CUTTING DEPTH WOOD **115mm**
MAX. CUTTING DEPTH STEEL **5mm**

FEATURES: lock-on button - soft grip -
adjustable pivot shoe - speed control - quick
blade change - rotatable rear handle

INCLUDED: 1x reciprocating saw - 1x blade
for metal - 1x blade for wood - 1x hex key



POWE30040

MINI PLUNGE SAW

MINI INVALZAAG | MINI SCIE PLONGEANTE
MINI TAUCHSÄGE | MINI SIERRA DE INMERSIÓN

POWE30040
500W



RATED VOLTAGE - FREQUENCY
230-240V ~ 50Hz
ROTATION SPEED **7000min⁻¹**
BLADE DIAMETER **85mm**
MAX. CUTTING DEPTH WOOD **25mm**
MAX. CUTTING DEPTH STEEL **3mm**
MAX. CUTTING DEPTH PLASTIC **5mm**

FEATURES: one handed operation - high
precision laser - allows plunge cutting

INCLUDED: 1x mini plunge saw - 1x side
guide - 1x dust adaptor - 1x blade for wood -
1x blade for multi-use - 1x blade for stone -
1x hex key



+ 3x SAW BLADE

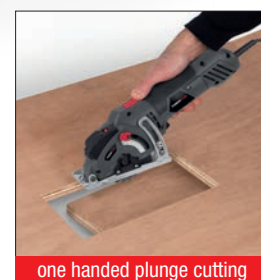

POWE30050

CIRCULAR SAW

CIRKELZAAG | SCIE CIRCULAIRE
HANDKREISSÄGE | SIERRA CIRCULAR

POWERPLUS



POWE30050
1200W

RATED VOLTAGE - FREQUENCY
220-240V ~ 50Hz
ROTATION SPEED **5500min⁻¹**
MAX. CUTTING CAPACITY
90°: **65mm** / 45°: **42mm**
BLADE SIZE **Ø185x20x2.4mm - 24T**

FEATURES: unlock button - safety guard -
soft grip - quick clamp for depth setting -
adjustable angle

INCLUDED: 1x circular saw - 1x side guide -
1x hex key - 1x blade for wood



POWE40010

FINISHING SANDER

VLAKSCHUURMACHINE | PONCEUSE VIBRANTE
SCHWINGSCHLEIFER | LIJADORA ORBITAL



POWE40010

180W

RATED VOLTAGE - FREQUENCY **230V~ 50Hz**
OSCILLATION SPEED **24000min⁻¹**
SANDING SURFACE **187x90mm**

FEATURES: paper clamps - hook & loop system - dust extraction - soft grip

INCLUDED: 1x finishing sander - 1x dust bag - 5x sandpaper (2x G80, 2x G120, 1x G240)



dust collection bag

paper clamps

hook & loop system



POWERPLUS

POWE40020

PALM SANDER

HANDPALMSCHUURMACHINE | PONCEUSE À MAIN
HANDSCHLEIFER | LIJADORA DE MANO



dustproof on/off switch

POWE40020

140W

RATED VOLTAGE - FREQUENCY **230V~ 50Hz**
OSCILLATION SPEED **26000min⁻¹**
SANDING SURFACE **140x140x80mm**

FEATURES: hook & loop system - dustproof switch - dust extraction - soft grip

INCLUDED: 1x palm sander - 1x dust bag - 5x sandpaper (2x G80, 2x G120, 1x G240)



dust collection bag

hook & loop system



POWE40030

ECCENTRIC SANDER

EXCENTRISCHE SCHUURMACHINE | PONCEUSE EXCENTRIQUE
EXZENTERSCHLEIFER | LIJADORA EXCÉNTRICA

POWERPLUS



+ 5x SANDPAPER



POWE40030

450W

RATED VOLTAGE - FREQUENCY **230V~ 50Hz**
OSCILLATION SPEED **12000-26000min⁻¹**
SANDING SURFACE **Ø125mm**

FEATURES: hook & loop system - dust extraction - speed control - adjustable auxiliary handle - soft grip

INCLUDED: 1x rotating sander - 1x dust bag - 5x sandpaper (2x G80, 2x G120, 1x G240)



5 400338 072697 >

POWE40040

BELT SANDER

BANDSCHUURMACHINE | PONCEUSE À BANDE
BANDSCHLEIFER | LIJADORA DE BANDA



+ 1x SANDING BELT

POWE40040

1010W

RATED VOLTAGE - FREQUENCY **230-240V~ 50Hz**
BELT SPEED **0-380m/min**
BELT SIZE **533x73mm**

FEATURES: dust extraction - guide handle - dust bag - speed control - soft grip

INCLUDED: 1x belt sander - 1x dust bag - 1x sanding belt (G80)



5 400338 073069 >

POWE40050

TRIANGULAR SANDER

DRIEHOEKSCHUURMACHINE | PONCEUSE TRIANGULAIRE
DREIECKSCHLEIFER | LIJADORA TRIANGULAR



POWE40050

180W

RATED VOLTAGE - FREQUENCY 230V~ 50Hz

OSCILLATION SPEED 22000min⁻¹

SANDING SURFACE 90x90x90mm

FEATURES: hook & loop system - dust extraction - soft grip

INCLUDED: 1x triangular sander - 1x dust adaptor - 1x sandpaper (G80)



hook & loop system

dust adaptor



+ 1x SANDPAPER

POWERPLUS

POWE41030

ANGLE POLISHER

HAAKSE POLIERMACHINE | POLLISEUSE D'ANGLE
WINKELPOLIERMACHINE | PULIDORA DE ÁNGULOS

POWE41030

1200W

RATED VOLTAGE - FREQUENCY

220-240V~ 50Hz

ROTATION SPEED 600-3500min⁻¹

DISC DIAMETER Ø180mm

SPINDLE THREAD M14

FEATURES: hook & loop system - soft start - constant speed control - U-shaped handle - variable speed - soft grip

INCLUDED: 1x angle polisher - 1x hex key - 1x sandpaper - 1x sponge pad - 1x polishing bonnet - 1x grip pad - 1x U-shaped handle



U-shaped handle

speed control dial

lock-on button

grip pad



POWE50002

MITRE SAW

MITRE SAW | SCIE À ONGLET
KAPP- UND GEHRUNGSSÄGE | SIERRA INGLETADORA

POWERPLUS

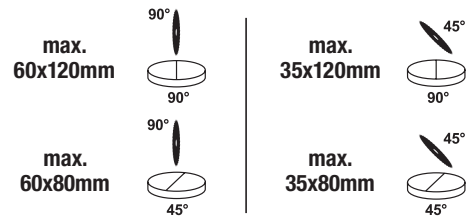

POWE50002 1650W

RATED VOLTAGE - FREQUENCY

220-240V ~ 50Hz

ROTATION SPEED **5000min⁻¹**

MAX. CUTTING CAPACITY **60x120mm**

BLADE SIZE **Ø210x30x2.8mm - 24T**

FEATURES: aluminium base - hinged saw blade guard - high precision laser - rotary table - scale for accurate horizontal angle positioning

INCLUDED: 1x mitre saw - 1x dust collection bag - 2x hex key - 1x clamp set - 2x extension bar - 1x rear support bar - 1x saw blade





POWE60015

VACUUM CLEANER WET/DRY

STOFZUIGER NAT/DROOG | ASPIRATEUR HUMIDE/SEC
STAUBSAUGER NAß/TROCKEN | ASPIRADOR HÚMEDO/SECO

POWERPLUS



blow function



tube - 3pcs

stainless steel tank

POWE60015
1000W

RATED VOLTAGE - FREQUENCY

220-240V - 50Hz

TANK CAPACITY **15L**

TANK **STAINLESS STEEL**

SUCION POWER **15kPa**

FEATURES: wet & dry function - vacuum & blow function - can be used without bag

INCLUDED: 1x vacuum cleaner - 1x dust bag - 1x hose - 1x crevice nozzle - 1x upholstery nozzle - 1x floor brush - 1x tube (3pcs) - 4x wheel



5 400338 073212 >



POWE90100

5x 8 LITRE DUST BAG

- 200x330mm
- FITS ON POW0350/POWE60015

POWE80010

OSCILLATING MULTITOOL

OSCILLERENDE MULTITOOL | MULTI-OUTIL OSCILLANT
OSZILLIERENDES MULTITOOL | MULTIHERRAMIENTA OSCILANTE



quick clamp system

on/off switch

speed control dial

+ 14 ACCESSORIES

POWE80010
350W

RATED VOLTAGE - FREQUENCY

230-240V - 50Hz

OSCILLATION SPEED **22000-42000min⁻¹**

SANDING SURFACE **90x90x90mm**

FEATURES: quick blade change system - soft grip - speed control - hook & loop system - auxiliary handle (2 positions) - alu gear box

INCLUDED: 1x multi-use tool - 1x auxiliary handle - 1x sanding plate - 10x sandpaper - 1x shovel blade - 1x plunge cut saw blade - 1x segment saw blade



5 400338 072536 >

POWE80030

PLANER

SCHAAFMACHINE | RABOT
HOBEL | CEPILLO

POWERPLUS

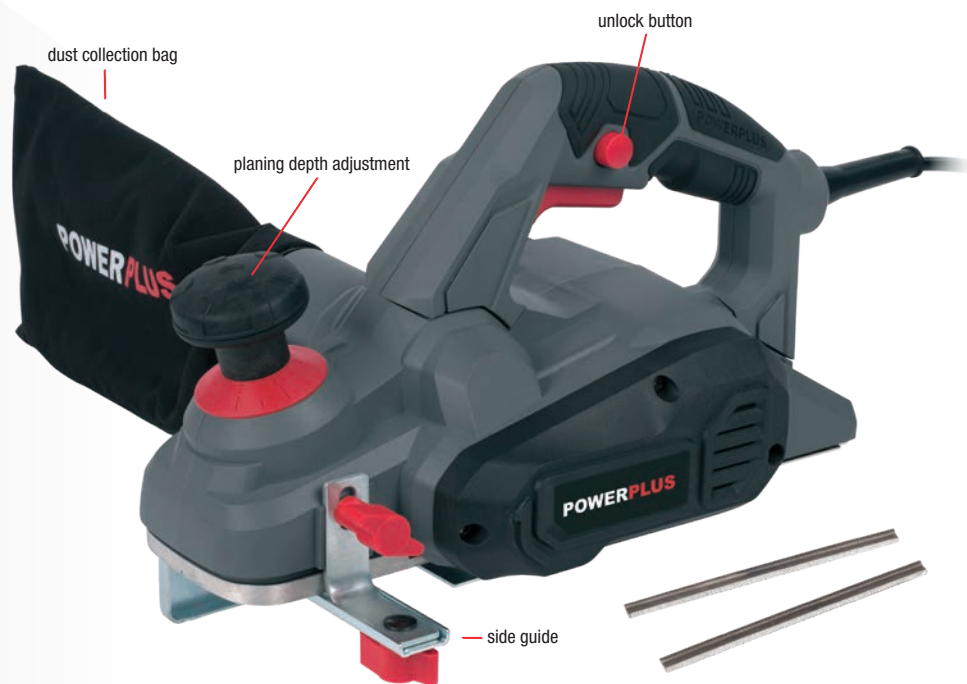

POWE80030 900W

RATED VOLTAGE - FREQUENCY
230-240V ~ 50Hz
ROTATION SPEED **17000min⁻¹**
PLANING WIDTH **82mm**
PLANING DEPTH **0-3mm**

FEATURES: dust extraction - adjustable
planing depth - unlock button

INCLUDED: 1x planer - 1x side guide -
1x spanner - 2x knife - 1x dust bag -
1x hex key



5 400338 073175 >

POWE80040

HEAT GUN

HETELUCHTPISTOOL | DÉCAPEUR
HEIßLUFTPISTOLE | DECAPADOR

POWE80040 1600W

RATED VOLTAGE - FREQUENCY
220-240V ~ 50Hz
HEAT AIRFLOW SETTINGS
I **380°C - 300 l/min**
(drying, shrinking, removing stickers,
waxing, thawing)
II **500°C - 500 l/min**

(welding/bending plastics, loosening nuts
and bolts, removing paint and lacquer,
soldering)

FEATURES: 2 airflow/heat settings - thermal
stop - cool grip - support - soft grip

INCLUDED: 1x heat gun - 1x reflector nozzle -
2x reduction nozzle - 1x spreader nozzle



5 400338 073182 >



support

+ 4x NOZZLE

POWE80050

WALL SLOTTER

MUURFREES | RAINUREUSE À MAÇONNERIE
MAUERNUTFRÄSE | RANURADORA DE PARED

POWERPLUS

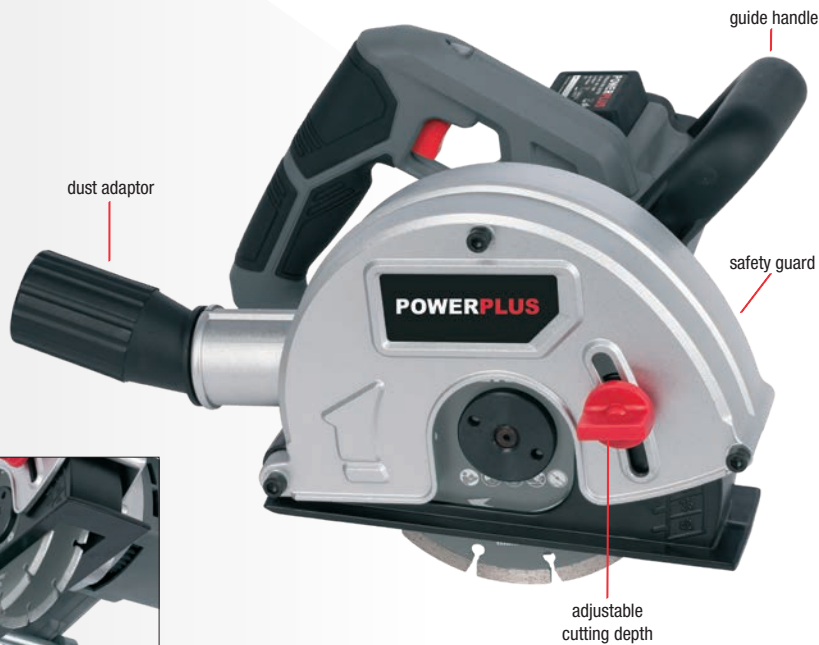

POWE80050
1700W

RATED VOLTAGE - FREQUENCY
230-240V ~ 50Hz
ROTATION SPEED **4500min⁻¹**
CUTTING DEPTH **40mm**
CUTTING WIDTH **14/19/29mm**
BLADE DIMENSIONS **Ø150x22.2mm (M12)**

FEATURES: adjustable cutting width - safety guard - guide handle - lock-on button - overload protection - soft grip - soft start

INCLUDED: 1x wall slotter - 2x diamond disc - 1x spanner - 1x scoop - 1x dust adaptor - 1x hex key



POWE80070

CONCRETE PAINT/MIXER

BETON-/VERFMENGER | MÉLANGEUR À BÉTON/PEINTURE
RÜHRWERK | MEZCLADOR ELÉCTRICO



POWE80070
1200W

RATED VOLTAGE - FREQUENCY **230V ~ 50Hz**
ROTATION SPEED **0-700min⁻¹**
CONNECTION TYPE **M14**
MAX. TORQUE **30Nm**
DIMENSIONS MIXING PADDLE
Ø120mm - L 590mm

FEATURES: alu gear box - soft grip

INCLUDED: 1x concrete paint/mixer - 1x mixing paddle - 2x spanner



POWE80090

POWER STATION

ENERGIESTATION | ALIMENTATION ÉLECTRIQUE
STROMGENERATOR | PUESTO DE ALIMENTACIÓN



pressure gauge

worklight

colour coded
battery meter



POWE80090

4-in-1

AIR PRESSURE **max. 17bar**
OUTPUT VOLTAGE **12V DC**
OUTPUT CURRENT **max. 6A**
STARTING CURRENT **max. 900A**

FEATURES: 4-in-1: jumpstart, emergency light, 12V DC power supply, compressor

INCLUDED: 1x power station - 1x charger - 3x nozzle - 12V DC power cord



5 400338 073229 >

POWERPLUS



POWE80060

MULTITOOL

MULTIGEREEDSCHAP | OUTIL POLYVALENT
MULTITOOL | HERRAMIENTA MULTITOOL

POWERPLUS



+40 ACCESSORIES



POWE80060

135W



RATED VOLTAGE - FREQUENCY **230V~ 50Hz**
ROTATION SPEED **8000 - 32500min⁻¹**
COLLET DIAMETER **2.4 - 3.2mm**

FEATURES: variable speed - spindle lock button - soft grip

INCLUDED: 1x multitool - 1x flexible tube - 1x stand - 1x table clamp - 40 accessories - 1x BMC



stand, clamp and flexible tube



POWE90600

MULTITOOL ACCESSORIES

MULTIGEREEDSCHAP ACCESSOIRES | ACCESSOIRES OUTIL POLYVALENT
ZUBEHÖR MULTITOOL | ACCESORIOS HERRAMIENTA MULTITOOL



POWE90600

102pcs

GRINDING STONES **11pcs**
 HSS ROUTER BITS **6pcs**
 COPPER BRUSHES **3pcs**
 NYLON BRUSHES **3pcs**
 DRUM SANDERS **2pcs**
 MANDREL **2pcs**
 SCREW MANDREL
 SANDING BANDS **22pcs**
 DRESSING STONE **1pc**
 POLISHING COMPOUND **1pc**
 CUT-OFF DISCS **25pcs**
 FIBREGLASS REINFORCED CUT-OFF DISCS **10pcs**
 COLLET **1pc**
 FELT POLISHING TIPS **5pcs**
 FELT POLISHING WHEELS **10pcs**



POWE80080 | POWE80085

BENCH GRINDER

BANKSLIJPMOLEN | TOURET
TISCHSCHLEIFMASCHINE | ESMERILADORA DE BANCO

POWERPLUS

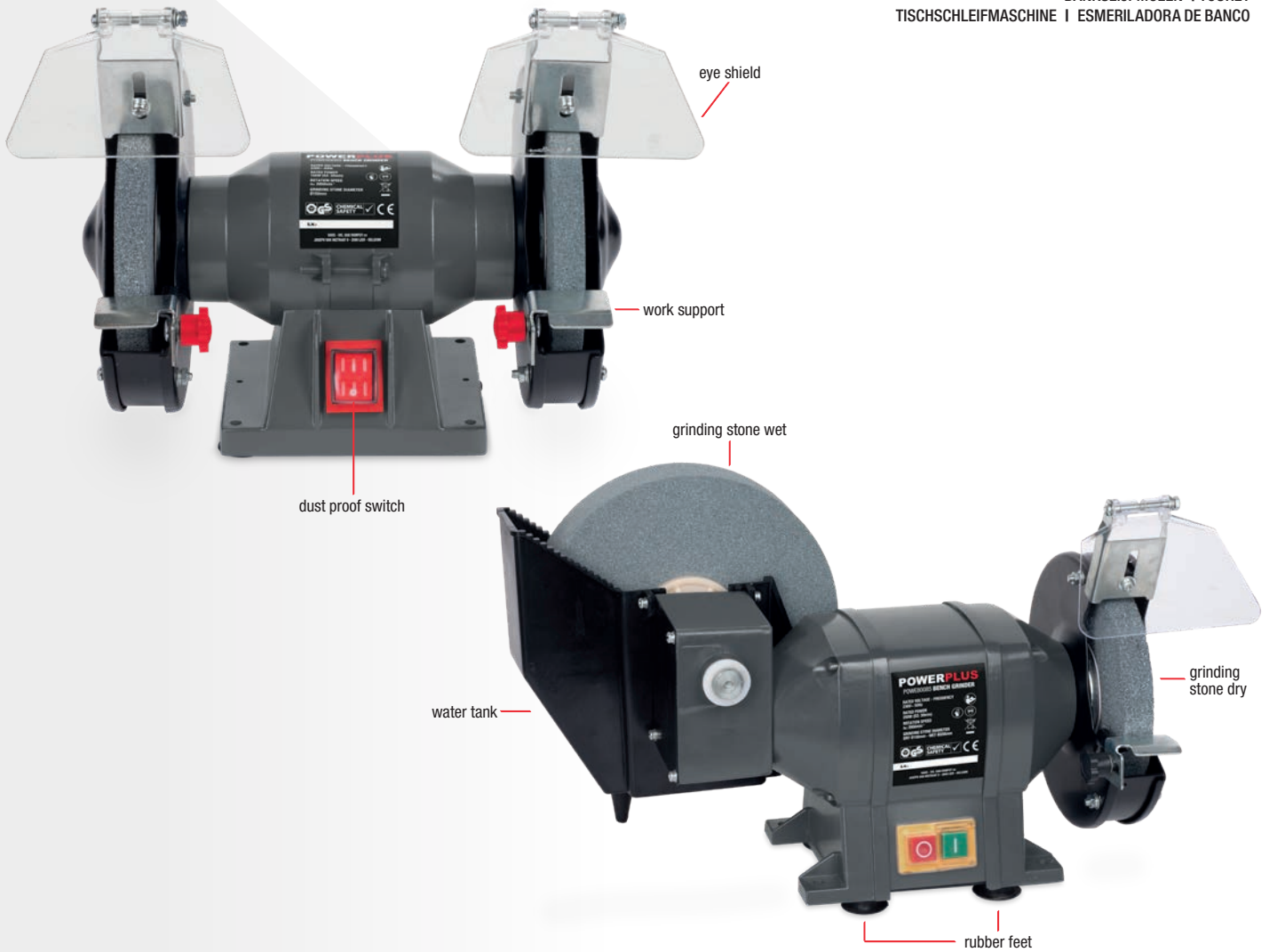

POWE80080 150W

RATED VOLTAGE - FREQUENCY **230V~ 50Hz**
ROTATION SPEED **2950min⁻¹**
GRINDING STONE **Ø150x16x12.7mm**

FEATURES: dry grinding - coarse & fine grinding

INCLUDED: 1x bench grinder - 2x eye shield - 2x work support - 2x grinding stone



5 400338 074394 >

POWE80085 250W

RATED VOLTAGE - FREQUENCY **230V~ 50Hz**
ROTATION SPEED **2950min⁻¹**
GRINDING STONE
DRY **Ø150x20x12.7mm**
WET **Ø200x40x20mm**

FEATURES: wet & dry grinding - coarse & fine grinding - eye shield - work support - rubber feet - water tank

INCLUDED: 1x bench grinder - 1x eye shield - 1x work support - 2x grinding stone



5 400338 074820 >





POWE SETS

The E-Line also has a number of practical tool sets. The power tools are supplied in a tough, durable and lightweight metal carrying case, together with a set of accessories. Everything the do-it-yourselfer needs to get started and tackle a variety of tasks.

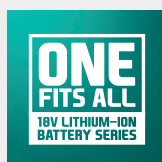

POWESET1
DRILL/SCREWDRIVER SET 18V

p43



POWESET2
ANGLE GRINDER SET 900W

p44



POWESET3
JIGSAW SET 710W

p45



POWESET4
CIRCULAR SAW SET 1200W

p47



POWESET5
PALM SANDER 140W

p48



POWESET6
IMPACT DRILL 720W

p49



POWESET1

DRILL/SCREWDRIVER SET

SCHROEFBOORMACHINE | PERCEUSE / VISSEUSE
BOHRSCRAUBER | TALADRO / ATORNILLADOR

**ONE
FITS ALL**
18V LITHIUM-ION
BATTERY SERIES

SEE PAGE 63

POWERPLUS



POWESET1

18V LI-ION



BATTERY CAPACITY **1300mAh Li-Ion**

CHARGING TIME **1h**

CHUCK TYPE **10mm double sleeve keyless chuck**

ROTATION SPEED **0-400 / 0-1500min⁻¹**

MAX. TORQUE **35Nm**

TORQUE POSITIONS **20+1**

FUNCTIONS **drilling / screwdriving**

CAPACITY STEEL **8mm**

CAPACITY WOOD **18mm**

FEATURES: LED worklight - 2 speed settings - double sleeve keyless chuck - quick stop - built-in bit holder - left/right function - soft grip

INCLUDED: 1x drill/screwdriver - 153 accessories - 1x charger - 2x 1300mAh Li-ion battery - 1x metal case



5 400338 076442 >

PROMO SET +153 ACCESSORIES

50x 25mm CRV bit

- ⊖ 2xSL2/2xSL4/2xSL6
- ⊕ 2xPH0/3xPH1/3xPH2/3xPH3
- ⊕ 2xPZ0/3xPZ1/3xPZ2/3xPZ3
- ⊕ 1xT10/2xT15/2xT20/T2x25/3xT27/2xT30/2xT40
- 2xH3/2xH4/2xH5/2xH6

3x 50mm CRV bit

- ⊕ PH1/PH2/PH3

1x 60mm CRV magnetic bit holder

6x HSS drill

3.0/3.5/4.0/4.5/5.0/6.0

3x stone drill

4.0/5.0/6.0

90x plug

30x 50x4mm
30x 50x5mm
30x 50x6mm

+ EXTRA BATTERY & CHARGER

POWESET2

ANGLE GRINDER SET

HAAKSE SLIJPER | MEULEUSE D'ANGLE
WINKELSCHLEIFER | AMOLADORA ANGULAR

POWERPLUS



POWESET2
900W



RATED VOLTAGE - FREQUENCY **230-240V~ 50Hz**
ROTATION SPEED **12000min⁻¹**
DISC DIAMETER **Ø125mm**
SPINDLE THREAD **M14**

FEATURES: spindle lock - quick clamp system - unlock button - auxiliary handle (2 positions)

INCLUDED: 1x angle grinder - 1x auxiliary handle - 5x disc - 1x brush - 1x spanner - 1x safety guard - 1x metal case



PROMO SET +6 ACCESSORIES

1x 125mm diamond disc WET
for tiles & ceramics

1x 125mm diamond disc DRY
for stone, roof tiles & concrete

1x 125mm diamond disc WET/DRY
for stone, roof tiles, concrete & bluestone

1x 125mm cutting disc
for inox/metal

1x abrasive flap disc G120

1x cup brush for metal

POWESET3

JIGSAW SET

DECOUPEERZAAG | SCIE SAUTEUSE
STICHSÄGE | SIERRA DE CALAR



POWERPLUS

POWESET3 710W



RATED VOLTAGE - FREQUENCY **230-240V~ 50Hz**
ROTATION SPEED **0-2800min⁻¹**
CUTTING CAPACITY STEEL **8mm**
CUTTING CAPACITY WOOD **65mm**
PENDULAR **4 positions**

FEATURES: adjustable base - T-shaped connection -
lock-on button - quick blade change - soft grip -
LED worklight - speed control

INCLUDED: 1x jigsaw - 20x jigsaw blade - 1x dust
adaptor - 1x side guide - 1x hex key -
1x metal case



PROMO SET +20 ACCESSORIES

5x 100x4mm 6TPI HCS
blade for wood
3x 100x2.5mm 10TPI HCS
blade for wood
1x 100x2.5mm 10TPI BIM
blade for hard wood
3x 100x4mm 6TPI BIM
blade for hard wood

3x 100x2.5mm 10TPI BIM
blade for laminate
3x 75x2mm 10TPI HSS
blade for metal
1x 100x3mm 8TPI HSS
blade for aluminium
1x 30GRITT x75mm HM
blade for ceramics



POWER PLUS

POWER PLUS

KRETT

POWESET4

CIRCULAR SAW SET

CIRKELZAAG | SCIE CIRCULAIRE
HANDKREISSÄGE | SIERRA CIRCULAR

POWERPLUS



POWESET4
1200W



RATED VOLTAGE - FREQUENCY **220-240V~ 50Hz**
ROTATION SPEED **5500min⁻¹**
MAX. CUTTING CAPACITY
90°: **65mm** / 45°: **42mm**
BLADE SIZE **Ø185x20x2.4mm - 24T**

FEATURES: unlock button - safety guard - soft grip -
quick clamp for depth setting - adjustable base

INCLUDED: 1x circular saw - 1x side guide - 1x hex
key - 4x saw blade - 1x metal case



PROMO SET
+4 ACCESSORIES

1x 24T blade for wood
1x 48T blade for wood
1x 60T blade for wood
1x 24T blade for wood and nails

POWESET5

PALM SANDER SET

HANDPALMSCHUURMACHINE | PONCEUSE À MAIN
HANDSCHLEIFER | LIJADORA DE MANO

POWERPLUS



POWESET5

140W



RATED VOLTAGE - FREQUENCY **230V~ 50Hz**
OSCILLATION SPEED **26000min⁻¹**
SANDING SURFACE **140x140x80mm**

FEATURES: hook & loop system - dust extraction -
dustproof switch - soft grip

INCLUDED: 1x palm sander - 100x sandpaper - 1x dust
bag - 1x metal case



PROMO SET +100 ACCESSORIES

sandpaper for wood	sandpaper for paint
10x G40	10x G80
10x G60	10x G120
10x G80	10x G180
10x G120	
10x G180	
10x G240	
10x G400	

POWESET6

IMPACT DRILL SET

KLOPBOORMACHINE | PERCEUSE À PERCUSSION
SCHLAGBOHRMASCHINE | TALADRO PERCUTOR

POWERPLUS

drill and impact
mode selector

keyless chuck

left/right function

lock-on button

speed control dial



POWESET6
720W



RATED VOLTAGE - FREQUENCY **230-240V~ 50Hz**
CHUCK TYPE **13mm Sanou keyless chuck + lock**
ROTATION SPEED **0-3000min⁻¹**
IMPACT RATE **0-48000 strokes per minute**
MAX. TORQUE **3Nm**
FUNCTIONS **drilling / impact drilling**
CAPACITY CONCRETE **13mm**
CAPACITY STEEL **8mm**
CAPACITY WOOD **25mm**

FEATURES: lock-on button - Sanou keyless chuck with lock function - left/right function - speed control - soft grip

INCLUDED: 1x impact drill - 259 accessories - 1x depth stop - 1x auxiliary handle - 1x metal case



PROMO SET +259 ACCESSORIES

9x concrete drill

- 3x 6mm
- 3x 8mm
- 3x 10mm

150x plug

- 50x 6mm
- 50x 8mm
- 50x 10mm

100x screw

- 50xPZ4 - 30mm
- 30xPZ5 - 40mm
- 20xPZ6 - 50mm

POWEG

Besides power tools, the E-Line also has a large section of garden equipment at low-entry prices. They are perfect for the gardener who occasionally enjoys working in the garden or maintaining small gardens.





POWEG10100
CHAINSAW 2000W

p52



POWEG10110
CHAINSAW 2200W

p52



POWEG2010
CHAINSAW 37.2CC

p53



POWEG3010
HEDGE TRIMMER 22.5CC

p54



POWEG4010
HEDGE TRIMMER 520W

p54



POWEG4500
GRASS/HEDGE SHEAR 7.2V

p55



POWEG5011
SHREDDER 2500W

p55



POWEG63703
LAWNMOWER 1000W

p56



POWEG63773
LAWNMOWER 98.5CC

p57



POWEG6015
GRASSTRIMMER 300W

p58



POWEG8012
BRUSH CUTTER 42.7CC

p59



POWEG7010
CULTIVATOR 1050W

p60



POWEG9012
**LEAF BLOWER/
VACUUM 3000W**

p61

POWEG10100 | POWEG10110

CHAINSAW

KETTINGZAAG | TRONÇONNEUSE
KETTENSÄGE | MOTOSIERRA

POWERPLUS

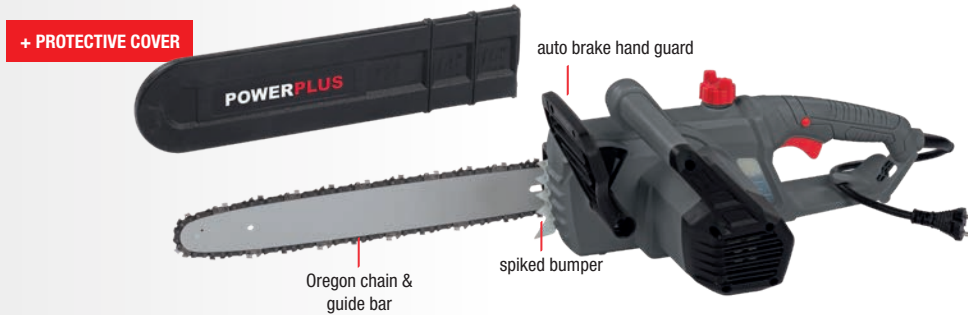
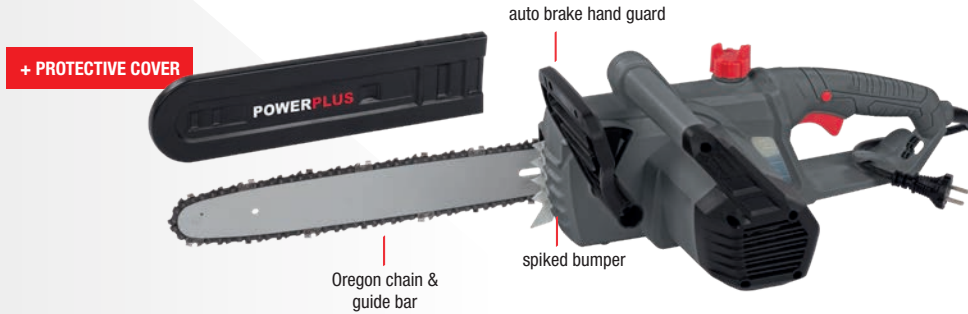

POWEG10100 2000W

RATED VOLTAGE - FREQUENCY **230-240V~ 50Hz**
 CHAIN ROTATION SPEED **15m/s**
 BAR SIZE **350mm / 14"**
 OIL TANK CAPACITY **280ml**

FEATURES: automatic chain oiler - oregon chain & guide bar - auto brake hand guard - low kickback - quick stop

INCLUDED: 1x chainsaw - 1x protective cover - 1x chain - 1x bar - 1x spanner

COMPATIBLE CHAIN: POWACG4222



POWEG10110 2200W

RATED VOLTAGE - FREQUENCY **230-240V~ 50Hz**
 CHAIN ROTATION SPEED **15m/s**
 BAR SIZE **400mm / 16"**
 OIL TANK CAPACITY **280ml**

FEATURES: automatic chain oiler - oregon chain & guide bar - auto brake hand guard - low kickback - quick and toolless chain adjustment - quick stop

INCLUDED: 1x chainsaw - 1x protective cover - 1x chain - 1x bar - 1x oil bottle 100ml (empty)

COMPATIBLE CHAIN: POWACG4231



POWEG2010

CHAINSAW

KETINGZAAG | TRONÇONNEUSE
KETTENSÄGE | MOTOSIERRA

POWERPLUS



TORCH
SPARK PLUG



use with fuel type

95 | 98 | E10



primer bulb

POWEG2010

37.2cc

ROTATION SPEED 10500min⁻¹

BAR SIZE 350mm / 14"

FUEL TANK CAPACITY 310ml

OIL TANK CAPACITY 210ml

FEATURES: 2-stroke engine - automatic chain oiler - oregon chain & guide bar - auto brake hand guard - low kickback - vibration reduction system - easy start system - automatic choke-off - quick stop

INCLUDED: 1x chainsaw - 1x protective cover - 1x chain - 1x bar - 1x oil bottle - 1x spark plug key - 1x file - 1x screwdriver - 2x hex key

COMPATIBLE CHAIN: POWACG4221

COMPATIBLE SPARK PLUG: POWACG2013



5 400338 073953 >



POWEG3010 | POWEG4010

HEDGE TRIMMER

HAAGSCHAAR | TAILLE-HAIE
HECKENSCHERE | CORTASETOS

POWERPLUS

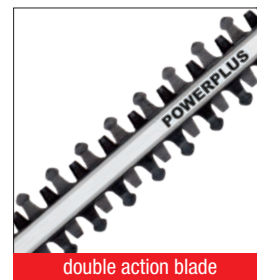
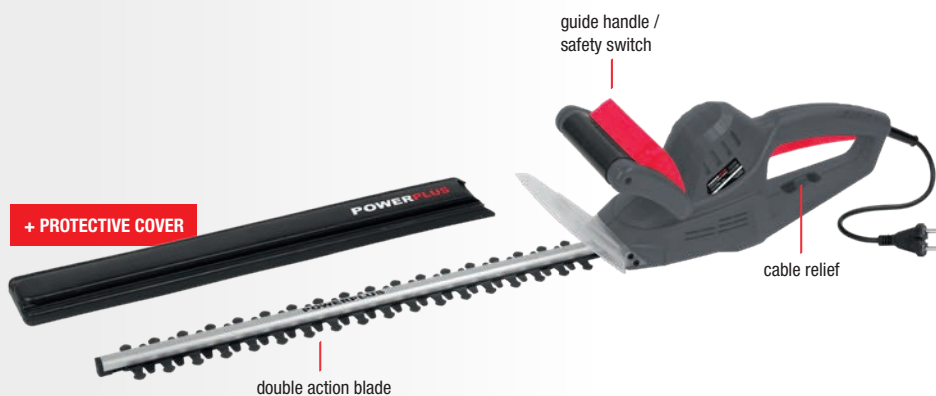

POWEG3010 22.5CC

ROTATION SPEED **max. 10000min⁻¹**
 KNIFE DISTANCE **28mm**
 FUEL TANK CAPACITY **580ml**
 BLADE LENGTH **600mm**
 CUTTING LENGTH **550mm**

FEATURES: Full crank engine - rotatable handle (5 positions) - double action blade - safety guard - 2 stroke engine - quick stop

INCLUDED: 1x hedge trimmer - 1x protective cover - 1x screwdriver - 1x socket wrench - 1x hex key - 1x spanner - 1x oil bottle

COMPATIBLE SPARK PLUG: POWACG2013



POWEG4010 520W

RATED VOLTAGE - FREQUENCY **220-240V ~ 50Hz**
 ROTATION SPEED **max. 1750min⁻¹**
 KNIFE DISTANCE **16mm**
 BLADE LENGTH **550mm**
 CUTTING LENGTH **510mm**

FEATURES: double action blade - electrical brake - two-handed operation - safety guard - quick stop

INCLUDED: 1x hedge trimmer - 1x protective cover



POWEG4500

GRASS/HEDGE SHEAR

GRAS-/HAAGSCHAAR | CISAILLA À GAZON/TAILLE-HAIE
RASEN-/HECKENSCHERE | TIJERAS CORTACÉSPED/CORTASETOS

POWEG4500

7.2V  LI-ION

ROTATION SPEED **1100min⁻¹**
BATTERY CAPACITY **1500mAh**
CHARGING TIME **3-5h**
SHRUB BLADE **120mm**
GRASS BLADE **83mm**

FEATURES: double action blade - quick stop -
quick blade change - LED charging indicator
lock-on button - soft grip

INCLUDED: 1x grass hedge shear - 2x blade -
2x protective cover - 1x charger



easy blade change

POWERPLUS

POWEG5011

SHREDDER

HAKSELAAR | BROYEUR DE VÉGÉTAUX
HÄCKSLER | TRITURADORA JARDÍN

POWEG5011

2400W

RATED VOLTAGE - FREQUENCY
230-240V ~ 50Hz
ROTATION SPEED **4050min⁻¹**
MAX. CUTTING DIAMETER **40mm**
SHREDDER BOX **50L**

FEATURES: overload protection - blade
adjustment - support foot - rotatable and
openable housing - safety contact -
blade cutting system

INCLUDED: 1x shredder - 2x wheel -
2x wheel cover - 1x shredder bag - 1x wheel
spindle - 2x wheel spindle sheath - 2x hex
wrench - 1x push stick



overload protection



BLADE CUTTING SYSTEM



push stick



openable housing

POWEG63703

LAWNMOWER

GRASMAAIER | TONDEUSE À GAZON
RASENMÄHER | CORTACÉSPED

POWERPLUS

2 FUNCTIONS

- REAR DISCHARGE
- COLLECTING SYSTEM



adjustable cutting height

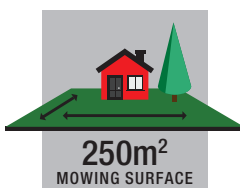

POWEG63703

1000W

RATED VOLTAGE - FREQUENCY **230-240V~ 50Hz**
 CUTTING WIDTH **320mm**
 ROTATION SPEED **max. 3450min⁻¹**
 ADJUSTABLE CUTTING HEIGHTS **25-65mm (3 pos.)**
 COLLECTION BOX **30L**

FEATURES: safety button - adjustable height setting - cable relief - collecting function - rear discharge function

INCLUDED: 1x lawnmower - 1x collection box



POWEG63773



3 FUNCTIONS

- REAR DISCHARGE
- MULCHING FUNCTION
- COLLECTING FUNCTION

LAWNMOWER

GRASMAAIER | TONDEUSE À GAZON
RASENMÄHER | CORTACÉSPED

POWERPLUS



SELF-PROPELLED
EXTRA COMFORTABLE MOWING

collection bag



mulching function



LG SPARK PLUG

1L: POWOIL023
5L: POWOIL025

use with fuel type
95|E10 98|E5



600m²
MOWING SURFACE

POWEG63773

132cc

ENGINE POWER 132cc / 2.5kW

CUTTING WIDTH 410mm

ROTATION SPEED max. 2800min⁻¹

ADJUSTABLE CUTTING HEIGHTS 25-75mm (7 pos.)

COLLECTION BAG 45L

FEATURES: central adjustable height setting - steel housing - eco driver 4-stroke engine - self-propelled - mulching function - collecting function - rear discharge function

INCLUDED: 1x lawnmower - 1x collection bag - 1x spark plug wrench - 1x mulch block - 1x blade - 4x lock knobs - 2x cord clamp - 1x lower rod

COMPATIBLE SPARK PLUG: POWAGC2011



5 400338 088582 >



POWEG6015

GRASS TRIMMER

GRASSTRIMMER | COUPE BORDURE
RASENTRIMMER | CORTABORDES

POWERPLUS



AUTOMATIC THREAD LENGTHENING SYSTEM



- TIME-SAVING
- FULLY SELF-ADJUSTING WIRE



double thread

POWEG6015

300W

RATED VOLTAGE - FREQUENCY **230V~ 50Hz**

CUTTING WIDTH **250mm**

ROTATION SPEED **10500min⁻¹**

SPOOL **Ø1.4mm - 6m (double thread)**

FEATURES: automatic thread lengthening system - guide handle - flower protection - safety guard - cable relief

INCLUDED: 1x grasstrimmer - 1x safety guard - 1x spool

COMPATIBLE SPOOL: POWAG1202



POWEG8011

BRUSH CUTTER

BOSMAAIER | DÉBROUSSILLEUSE
FREISCHNEIDER | DESBROZADORA

POWERPLUS



+ SHOULDER HARNESS

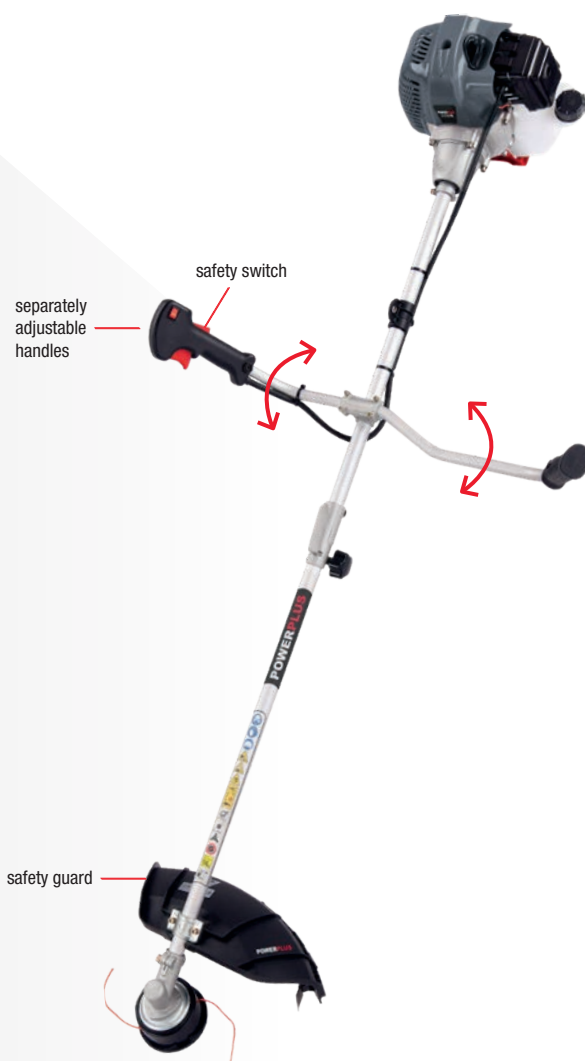

GRASS TRIMMER



2 IN 1
BRUSH CUTTER

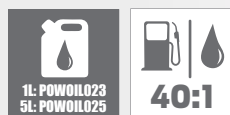

use with fuel type
95|E10 98|E5

POWEG8011

42.7cc

CUTTING WIDTH TRIMMER 420mm / CUTTER 255mm
ROTATION SPEED TRIMMER 8900min⁻¹ / CUTTER 9200min⁻¹
FUEL TANK CAPACITY 1300ml
BLADE 255mmx25.4mm - 3T
SPOOL 02.4mm - 2.8m (double thread)

FEATURES: tap & go lengthening system - easy start -
2-stroke engine - bike handle - double shoulder harness -
quick harness disconnection - separately adjustable handles -
Bosch spark plug - safety guard - vibration reduction system

INCLUDED: 1x brush cutter - 1x double shoulder harness -
1x spool - 1x steel brush cutting blade - 1x bike handle -
1x protective cover - 1x toolset - 1x mixing bottle

COMPATIBLE SPOOL: POWACG1051

COMPATIBLE BLADE: POWACG3021

COMPATIBLE SPARK PLUG: POWACG2013



POWEG7010

CULTIVATOR

TUINFREES | MOTOCULTEUR
BODENHACKE | MOTOCULTOR

POWERPLUS

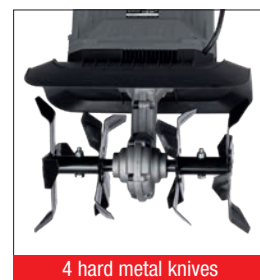

POWEG7010

1050W

RATED VOLTAGE - FREQUENCY 230-240V ~ 50Hz
WORKING WIDTH 320mm
MAXIMUM WORKING DEPTH 220mm
KNIFE THICKNESS 1.7mm

FEATURES: cable relief - 4 hard metal knives - bike handle - safety switch

INCLUDED: 1x cultivator



POWEG9012

LEAF BLOWER / VACUUM

BLADBLAZER/-ZUIGER | ASPIRATEUR/SOUFFLEUR DE FEUILLES
LAUBSAUGER/BLÄSER | SOPLADOR/ASPIRADOR DE HOJAS

POWERPLUS



+ CARRYING BELT

3 FUNCTIONS



BLOWING



VACUUMING



SHREDDING



vacuum/blower lever



quick release collection bag

POWEG9012

3000W

RATED VOLTAGE - FREQUENCY 230-240V~ 50Hz

ROTATION SPEED 15000min⁻¹

COLLECTION BAG 40L

MAX. VELOCITY 250km/h

MAX. AIR VOLUME 10m³/min

SHREDDING RATIO 10:1

FEATURES: 3 functions: shredding, blowing & vacuuming - quick release collection bag - double wheel support - tube: 2 pieces for compact storage - lightweight

INCLUDED: 1x leaf blower/vacuum - 1x tube (2 parts) - 1x collection bag - 1x carrying belt - 2x wheel



POWERPLUS



**ONE
FITS ALL**
18V LITHIUM-ION
BATTERY SERIES

**ONE BATTERY FITS ALL
EB-RANGE 18V POWER
AND GARDEN TOOLS**

**BATTERY AND CHARGER
ARE NOT INCLUDED**

POWERB

New in the E-Line product range is the 'One Fits All' 18V battery system.

With only one battery you can operate a whole range of 18V tools. It offers endless possibilities and total freedom.

There are two 18V Li-ion battery models to choose from: one with a capacity of 1,5 Ah and the other with 3,0 Ah. The 3,0 Ah battery allows a longer runtime.



POWEB1510
DRILL/SCREWDRIVER 18V

p64



POWEB1520
**IMPACT DRILL/
SCREWDRIVER 18V**

p64



POWEB2010
IMPACT SCREWDRIVER 18V

p65



POWEB2015
IMPACT WRENCH 18V

p65



POWEB2510
RECIPROCATING SAW 18V

p66



POWEB2520
CIRCULAR SAW 18V

p66



POWEB2530
JIGSAW 18V

p67



POWEB3011
**OSCILLERENDE
MULTITOOL 18V**

p67



POWEB3510
ANGLE GRINDER 18V

p69



POWEB4010
ROTATING SANDER 18V

p70



POWEB4020
PALM SANDER 18V

p70



POWEB5010
AIR PRESSURE PUMP 18V

p71



POWEB5510
PAINT SPRAY GUN 18V

p71

POWEB1510

DRILL/SCREWDRIVER

SCHROEFBOORMACHINE | PERCEUSE/VISSEUSE
BOHRSCHRAUBER | TALADRO/ATORNILLADOR

**ONE
FITS ALL**
18V LITHIUM-ION
BATTERY SERIES

POWERPLUS



torque adjustment ring 20+1

POWEB1510
18V

ROTATION SPEED **0-400 / 0-1500min⁻¹**
 CHUCK TYPE
10mm double sleeve keyless chuck
 MAX. TORQUE **35Nm**
 TORQUE POSITIONS **20+1**
 FUNCTIONS **drilling / screwdriving**
 CAPACITY STEEL **8mm**
 CAPACITY WOOD **18mm**

FEATURES: LED worklight - 2 speed settings - double sleeve keyless chuck - quick stop - built-in bit holder - left/right function - soft grip

INCLUDED: 1x drill/screwdriver

NOT INCLUDED: battery - charger



5 400338 075834 >

POWEB1520

IMPACT DRILL/SCREWDRIVER

SLAGSCHROEFBOORMACHINE | PERCEUSE/VISSEUSE À PERCUSSION
SCHLAGBOHRSCHRAUBER | TALADRO/ATORNILLADOR DE IMPACTO



LED worklight

POWEB1520
18V

ROTATION SPEED **0-400 / 0-1500min⁻¹**
 CHUCK TYPE **13mm keyless chuck**
 IMPACT RATE
0-6400/0-24000 strokes per minute
 MAX. TORQUE **50Nm**
 TORQUE POSITIONS **23+1+1**
 FUNCTIONS **drilling / impact drilling**
 CAPACITY STEEL **8mm**
 CAPACITY WOOD **22mm**
 CAPACITY CONCRETE **12mm**

FEATURES: impact function - quick stop - LED worklight - 2 speed settings keyless chuck - left/right function - soft grip

INCLUDED: 1x impact drill/screwdriver - 1x auxiliary handle - 1x depth stop

NOT INCLUDED: battery - charger



5 400338 075841 >

**ONE
FITS ALL**
18V LITHIUM-ION
BATTERY SERIES

POWEB2010

IMPACT SCREWDRIVER

SLAGSCHROEVENDRAAIER | VISSEUSE À PERCUSSION
SCHLAG-SCHRAUBENDREHER | DESTORNILLADOR DE IMPACTO

POWEB2010

18V

ROTATION SPEED 0-2000min⁻¹

MAX. TORQUE 80Nm

IMPACT RATE 0-3000 strokes per minute

SOCKET TYPE 1/4" hex

FEATURES: LED worklight - quick stop -
left/right function - impact function - soft grip

INCLUDED: 1x impact screwdriver

NOT INCLUDED: battery - charger



5 400338 075865 >



socket type 1/4" hex

POWERPLUS

POWEB2015

IMPACT WRENCH

SLAGMOERSLEUTEL | CLÉ À CHOC
SCHLAGSCHRAUBER | LLAVE DE IMPACTO

POWEB2015

18V

ROTATION SPEED 0-2000min⁻¹

MAX. TORQUE 160Nm

IMPACT RATE 0-3000 strokes per minute

SOCKET TYPE 3/8" with 1/2" adaptor

FEATURES: LED worklight - quick stop -
left/right function - impact function - soft grip

INCLUDED: 1x impact wrench

NOT INCLUDED: battery - charger



5 400338 075858 >



socket type 3/8" with 1/2" adaptor

POWEB2510

RECIPROCATING SAW

RECIPROZAAG | SCIE SABRE
SÄBELSÄGE | SIERRA DE ESPADA

**ONE
FITS ALL**
18V LITHIUM-ION
BATTERY SERIES

POWERPLUS



quick blade change



POWEB2510

18V_{Li-Ion}

ROTATION SPEED **0-2600min⁻¹**
MAX. CUTTING DEPTH WOOD **100mm**
MAX. CUTTING DEPTH STEEL **6mm**

FEATURES: unlock button - soft grip -
adjustable pivot shoe - quick blade change

INCLUDED: 1x reciprocating saw

NOT INCLUDED: saw blade - battery -
charger



5 400338 076046 >

POWEB2520

CIRCULAR SAW

CIRKELZAAG | SCIE CIRCULAIRE
HANDKREISSÄGE | SIERRA CIRCULAR



scale for mitre angle



POWEB2520

18V_{Li-Ion}

ROTATION SPEED **4000min⁻¹**
MAX. CUTTING CAPACITY
90°: **52mm** / 45°: **38mm**
BLADE SIZE **Ø165x20x2.2mm - 18T**

FEATURES: unlock button - safety guard -
soft grip - angle adjustment - scale for mitre
angle

INCLUDED: 1x circular saw - 1x side guide -
1x hex key - 1x blade for wood

NOT INCLUDED: battery - charger



5 400338 076039 >

**ONE
FITS ALL**
18V LITHIUM-ION
BATTERY SERIES

POWEB2530

JIGSAW

DECOUPEERZAAG | SCIE SAUTEUSE
STICHSÄGE | SIERRA DE CALAR

POWEB2530

18V

ROTATION SPEED **0-2500**min⁻¹
PENDULAR **4 positions**
CAPACITY STEEL **8mm**
CAPACITY WOOD **65mm**
CAPACITY PLASTIC **20mm**

FEATURES: adjustable base - T-shaped connection - lock-on button - quick blade change - soft grip - LED worklight

INCLUDED: 1x jigsaw - 1x blade for wood

NOT INCLUDED: battery - charger



POWERPLUS

COMING SOON

POWEB3011

OSCILLERENDE MULTITOOL

OSCILLERENDE MULTITOOL | MULTI-OUTIL OSCILLANT
OSZILLIERENDES MULTITOOL | MULTIHERRAMIENTA OSCILANTE



POWEB3011

18V

OSCILLATION SPEED **4000-36000**min⁻¹
SANDING SURFACE **90x90x90mm**
SPEED SETTINGS **6**

FEATURES: quick release system - variable speed - soft grip - hook & loop system

INCLUDED: 1x multitool - 2x saw blade - 1x shovel blade - 1x triangular sanding pad - 3x sandpaper (2xG120, 1xG240)

NOT INCLUDED: disc - battery - charger





**ONE
FITS ALL**
18V LITHIUM-ION
BATTERY SERIES

POWEB3510

ANGLE GRINDER

HAAKSE SLIJPER | MEULEUSE D'ANGLE
WINKELSCHLEIFER | AMOLADORA ANGULAR

POWERPLUS



POWEB3510

18V

ROTATION SPEED **7000min⁻¹**
DISC DIAMETER **Ø115mm**
SPINDLE THREAD **M14**

FEATURES: safety guard - spindle lock -
auxiliary handle (2 positions) - soft grip

INCLUDED: 1x angle grinder - 1x auxiliary
handle - 1x spanner - 1x safety guard

NOT INCLUDED: disc - battery - charger



5 400338 076053 >

POWEB4010

ROTATING SANDER

ROTERENDE SCHUURMACHINE | PONCEUSE ROTATIVE
EXZENTERSCHLEIFER | LIJADORA ROTO-ORBITAL

**ONE
FITS ALL**
18V LITHIUM-ION
BATTERY SERIES

POWERPLUS



POWEB4010

18V

OSCILLATION SPEED **20000**min⁻¹
SANDING SURFACE **Ø125mm**

FEATURES: hook & loop system - dust extraction - dustproof switch - soft grip

INCLUDED: 1x rotating sander - 1x dust bag - 1x sandpaper (G120)

NOT INCLUDED: battery - charger



POWEB4020

PALM SANDER

HANDPALMSCHUURMACHINE | PONCEUSE À MAIN
HANDSCHLEIFER | LIJADORA DE MANO



POWEB4020

18V

OSCILLATION SPEED **22000**min⁻¹
SANDING SURFACE **140x140x80mm**

FEATURES: hook & loop system - dustproof switch - soft grip

INCLUDED: 1x palm sander - 6x sandpaper (2x G120, 2x G180, 2x G240)

NOT INCLUDED: battery - charger



**ONE
FITS ALL**
18V LITHIUM-ION
BATTERY SERIES

POWEB5010

AIR PRESSURE PUMP

LUCHTDRUKPOMP | POMPE À PRESSION ATMOSPHÉRIQUE
LUFTDRUCKPUMPE | BOMBA DE PRESIÓN DE AIRE

POWEB5010

18V₌₌

MAX. PRESSURE **8bar**

AIR DEBIT **8 l/min**

FEATURES: pressure gauge - storage for accessories - flexible hose - wrist strap - soft grip

INCLUDED: 1x air pressure pump - 1x ball adaptor - 1x bicycle tyre adaptor - 1x car tyre adaptor - 1x airbed adaptor - 1x flexible tube

NOT INCLUDED: battery - charger



POWERPLUS

POWEB5510

PAINT SPRAY GUN

VERFPISTOOL | PISTOLET PULVÉRISATEUR DE PEINTURE
FARBSPRITZPISTOLE | PISTOLA DE PINTURA



POWEB5510

18V₌₌

FLOW SPEED **300g/min**

NOZZLE **00.8mm**

TANK CAPACITY **1L**

MAX. VISCOSITY **60din/sec**

FEATURES: round spray pattern - output control - lock-on button - adjustable paint flow control - spray full latex paint - soft grip

INCLUDED: 1x paint spray gun - 1x viscosity measuring cup - 1x spray basket nozzle - 1x nozzle wrench - 2x valve - 1x cleaning pin

NOT INCLUDED: battery - charger





**ONE
FITS ALL**

**18V LITHIUM-ION
BATTERY SERIES**

**ONE BATTERY FITS ALL
EB-RANGE 18V POWER
AND GARDEN TOOLS**

POWER BATTERIES AND CHARGERS



**POWEB9010
BATTERY 18V LI-ION 1.5Ah**

p74



**POWEB9013
BATTERY 18V LI-ION 3.0Ah**

p74



**POWEB9050
CHARGER 18V**

p75



**POWEB9090
2X BATTERY 18V LI-ION 1.5Ah
2X CHARGER 18V**

p75

POWEB9010 | POWEB9013

BATTERY

BATTERIJ | BATTERIE
BATTERIE | BATERÍA

**ONE
FITS ALL**
18V LITHIUM-ION
BATTERY SERIES

POWERPLUS



LI-ION ADVANTAGES

- ▶ NO SELF-DISCHARGE
- ▶ NO MEMORY EFFECT
- ▶ LONGER LIFE SPAN
- ▶ HIGHER ENERGY DENSITY
- ▶ LIGHTER WEIGHT
- ▶ ECO-FRIENDLY

POWEB9010

18V_≡ 1.5Ah

BATTERY CAPACITY **1500mAh**
BATTERY TYPE **LITHIUM-ION**

INCLUDED: 1x battery



POWEB9013

18V_≡ 3.0Ah

BATTERY CAPACITY **3000mAh**
BATTERY TYPE **LITHIUM-ION**

INCLUDED: 1x battery



**ONE
FITS ALL**
18V LITHIUM-ION
BATTERY SERIES

POWEB9050

CHARGER

LADER | CHARGEUR
LADEGERÄT | CARGADOR

POWERPLUS



POWEB9050

18V

CHARGER OUTPUT CURRENT

21.0VDC - 1.7A

CABLE LENGTH 1.8m

CHARGING TIME POWEB9010 60min

CHARGING TIME POWEB9013 120min

FEATURES: for indoor use only

INCLUDED: 1x charger



POWEB9090

SET: 2x BATTERY + 2x CHARGER

2x BATTERIJ + 2x LADER | 2x BATTERIE + 2x CHARGEUR
2x BATERIE + 2x LADEGERÄT | 2x BATERÍA + 2x CARGADOR

POWEB9090

18V

BATTERY CAPACITY 1500mAh

BATTERY TYPE LITHIUM-ION

CHARGER OUTPUT CURRENT

21.0VDC - 1.7A

CABLE LENGTH 1.8m

CHARGING TIME POWEB9010 60min

CHARGING TIME POWEB9013 120min

INCLUDED: 2x battery - 2x charger



POWERPLUS

POWC | POWE | POWEG | POWERB

VARO - VIC. VAN ROMPUY NV
JOSEPH VAN INSTRAAAT 9 - 2500 LIER - BELGIUM
TEL +32 (0)3 292.92.92 - FAX +32 (0)3 292.92.72
E-MAIL: INFO@VARO.COM - WWW.VARO.COM

OFFICES:
IBERICA BRICOLAGE S.L. - ESPAÑA
ASIA PACIFIC HONG KONG LTD / SHANGHAI PRC
AUSTRALIA PTY LTD / GERMANY GMBH

CAT19120088 PRINTED FEBRUARY 2020

© COPYRIGHT VARO - VIC. VAN ROMPUY NV 2020 / PRODUCT SPECIFICATIONS ARE SUBJECT TO CHANGE WITHOUT NOTICE. VARO IS NOT RESPONSIBLE FOR TYPOGRAPHICAL OR PHOTOGRAPHIC ERRORS THAT MAY APPEAR IN THIS CATALOGUE. PICTURES MAY VARY FROM THE ACTUAL PRODUCTS. WE RESERVE THE RIGHT TO MAKE ADJUSTMENTS OR CORRECTIONS DUE TO ERRORS, CHANGING MARKET CONDITIONS, PRODUCT DISCONTINUATIONS, OR TYPOGRAPHIC OR PHOTOGRAPHIC ERRORS IN ADVERTISEMENTS OR PRODUCT DESCRIPTIONS. ITEM AVAILABILITY AND PRICES ARE SUBJECT TO CHANGE WITHOUT NOTICE.

